

WALL SYSTEM ERECTION STEP BY STEP GUIDE

FAST-FORM DOUBLE-SIDED WALL SYSTEM

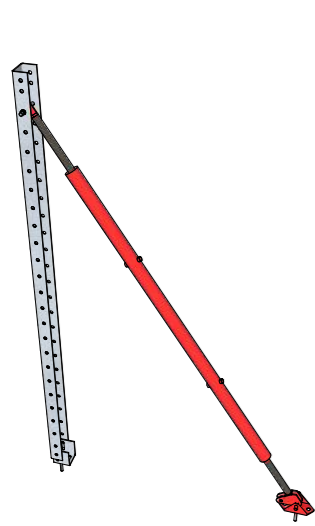

STEP ONE:
DRILL AND FIX FIRST UPRIGHT TO THE LINE OF THE WALL MINUS THE PLYWOOD THICKNESS. FOLLOW THE MANUFACTURER'S TECHNICAL APPROVAL AND INSTALLATION GUIDES TO PROPERLY SECURE THE CONCRETE BOLTS.

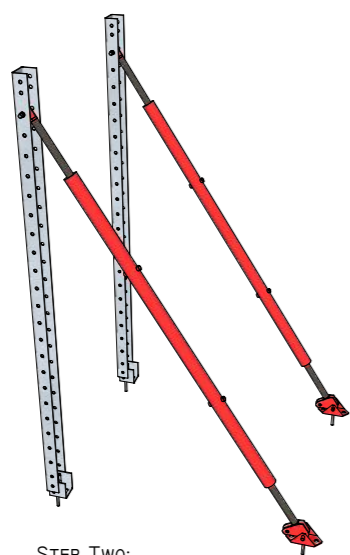

STEP TWO:
REPEAT FOR THE NEXT UPRIGHT USING THE HORIZONTAL BRACE TO SET THE DISTANCE APART.

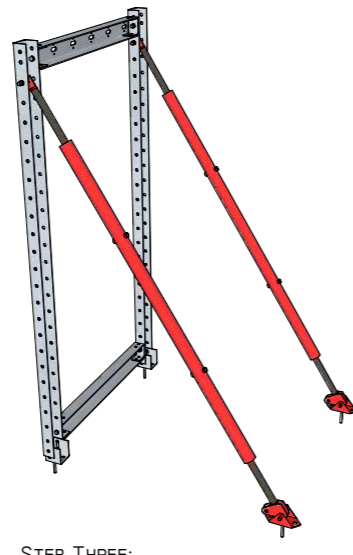

STEP THREE:
LOOSELY BOLT BOTTOM AND TOP HORIZONTAL JOINING MEMBERS.

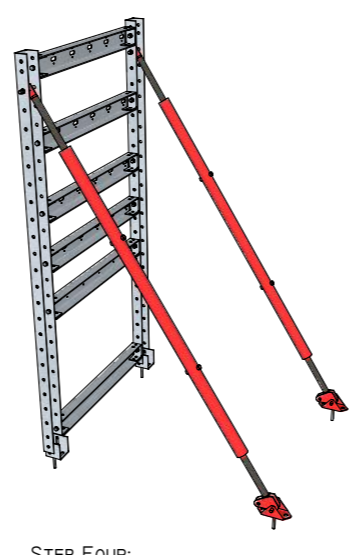

STEP FOUR:
FILL IN REMAINING HORIZONTAL JOINING MEMBERS.

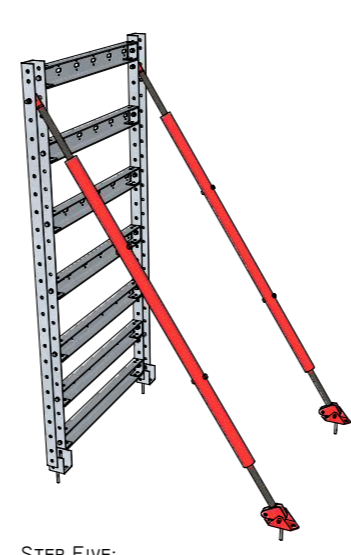

STEP FIVE:
TIGHTEN ALL BOLTS AND PLUMB THE UPRIGHTS.

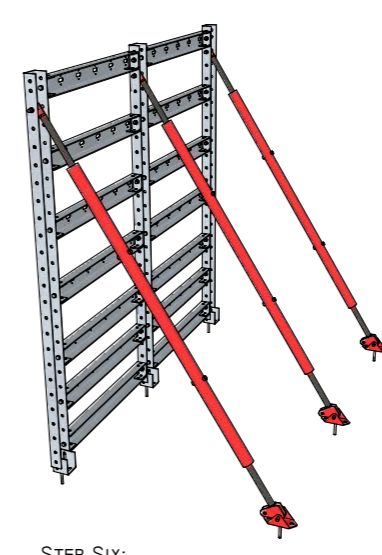

STEP SIX:
REPEAT THE PROCESS FOR NEXT UPRIGHTS.

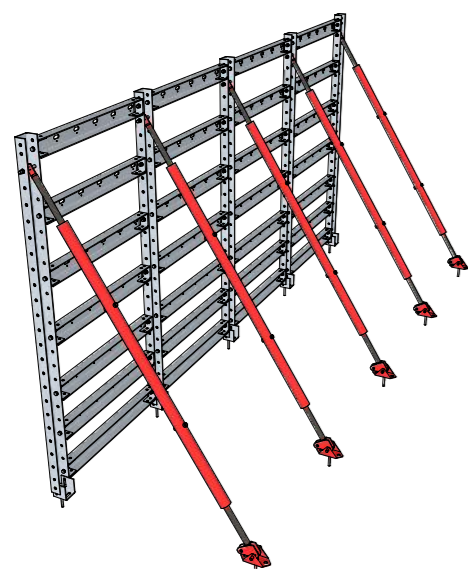

STEP SEVEN:
REPEAT FOR NEXT UPRIGHT UNTIL ALL ARE FIXED.

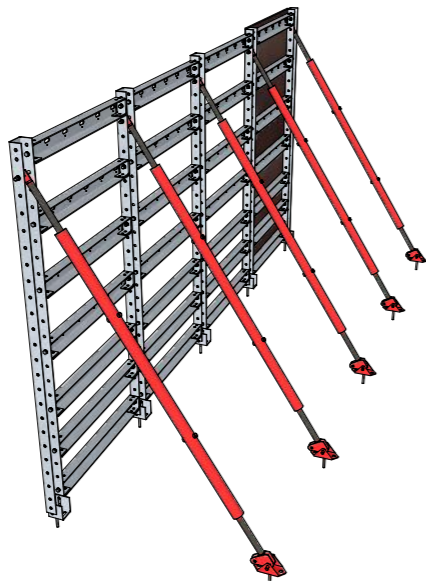

STEP EIGHT:
START FIXING THE PLYWOOD SECURING IT FROM BEHIND USING 25MM WOOD SCREWS. MAKE SURE THE PLYWOOD JOINTS FALL ON THE CENTRE OF THE UPRIGHTS OR THE HORIZONTAL JOINING MEMBERS.

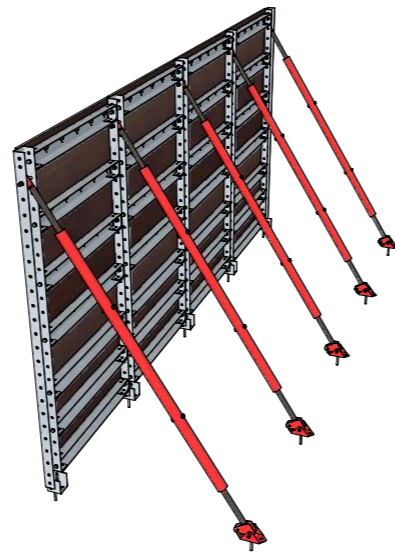

STEP NINE:
REPEAT THE PROCESS FOR THE WHOLE LINE OF THE WALL.

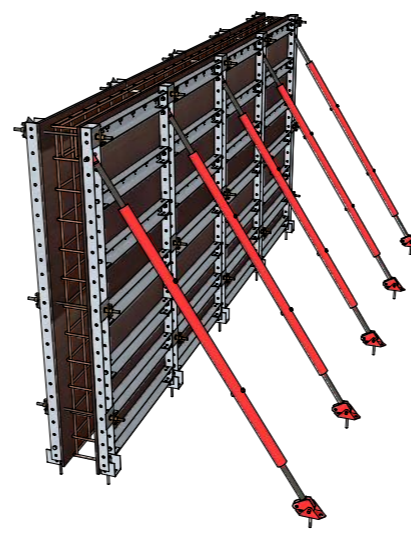

STEP TEN:
FIX REBAR AND THEN FIT OPPOSITE UPRIGHTS WHICH ARE SECURED TO THE GROUND IN THE SAME WAY BUT ALSO CONNECTED TO THE OPPOSITE UPRIGHTS USING TIE BARS. REMEMBER TO PUT ON THE SLEEVES ON THE TIE BARS BEFORE POSITIONING THE OPPOSITE UPRIGHTS. SECURE THE STOP-ENDS (PROVIDED BY CLIENT) AND TIGHTEN TIE BARS [REFER TO DRAWINGS FFS-SE# FOR STOP-END EXAMPLES].

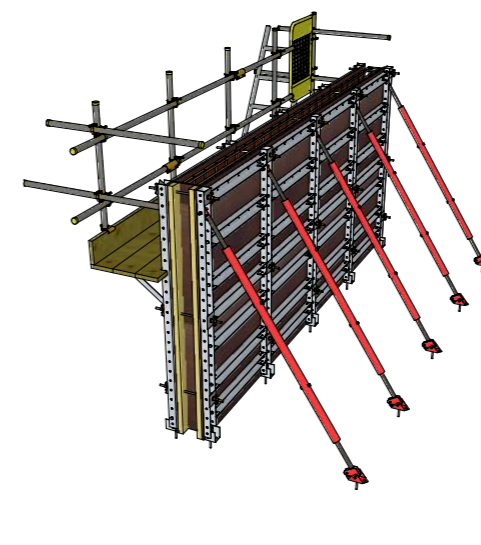

STEP ELEVEN:
FIX HANDRAILS / ACCESS IF REQUIRED [REFER TO DRAWINGS FFS-APHR# FOR MORE DETAILS].

IMPORTANT NOTES:

THESE ARE STANDARD FITTING INSTRUCTIONS FOR THE FAST FORM WALL SYSTEM, YOU SHOULD BE ABLE TO COMPLETE ANY SIZE OR TYPE OF POUR FOLLOWING THESE:

1. START BY MARKING OUT THE LINE OF THE SHUTTER (REMEMBER TO DEDUCT THE PLYWOOD THICKNESS). DRILL A HOLE FOR THE CONCRETE BOLT IN ACCORDANCE WITH MANUFACTURER'S TECHNICAL APPROVAL AND INSTALLATION GUIDES. FOR TWO SIDED FAST FORM WALL SYSTEM USE 1X CONCRETE BOLT PER UPRIGHT AND 1X PER PROP'S FOOT. ALL CONCRETE BOLTS SHOULD BE TIGHTENED WITH A 110V IMPACT WRENCH.

IMPORTANT

2. ALWAYS START WORKING FROM THE INSIDE CORNER, MOVING AWAY FROM IT. [REFER TO DRAWING NO FFS-WSTC FOR MORE DETAILS].

3. THE HORIZONTAL JOINING MEMBERS ARE USED TO SET THE DISTANCE BETWEEN THE UPRIGHTS AND THIS WILL REMAIN CONSTANT ONCE SET [1220MM CENTRE TO CENTRE OF UPRIGHTS] SO YOU CAN MARK AND DRILL ALL THE HOLES AHEAD OF YOU.

4. WHEN INSERTING THE HORIZONTAL JOINING MEMBERS DO NOT TIGHTEN UNTIL ALL HAVE BEEN FITTED LOOSELY FIRST.

5. WORK ALONG A SECTION AT A TIME, TIGHTENING AS YOU GO, YOU CAN FIX THE PLYWOOD AS YOU GO. THE PLYWOOD CAN BE FITTED HORIZONTALLY OR VERTICALLY AND IS FIXED FROM BEHIND WITH 25MM STANDARD WOOD SCREWS. IF THE REBAR IS ALREADY FIXED IT MAY BE EASIER TO FIX THE PLYWOOD HORIZONTALLY AND FIX BOTH BOTTOM SIDES BEFORE MOVING UP AS THIS WILL ALLOW MORE ROOM TO WORK.

6. WISAFORM MDO PLYWOOD, IF SUPPLIED BY FAST FORM SYSTEMS, THE LIGHT BROWN FACE IS THE FACE TO USE FOR THE CONCRETE SIDE, NOT THE DARK BROWN FACE. ALL PLYWOOD SHOULD BE SUITABLY OILED FOR EASY RELEASE AFTER CONCRETING.

7. ONCE ERECTED, PANELS CAN BE LIFTED AND MOVED. THE SYSTEM DOES NOT HAVE TO BE DISMANTLED AND RE-ERECTED EVERY TIME. BEFORE CONDUCTING A LIFT PLEASE CONSULT WITH FAST FORM SYSTEMS! A COMPETENT PERSON SHOULD SUPERVISE THE LIFTS AND ONLY SUITABLE LIFTING EQUIPMENT SHOULD BE USED.

8. IF ACCESS AND HANDRAILS HAVE BEEN REQUESTED BY THE CLIENT, THEY SHOULD BE FITTED BY A COMPETENT PERSON AND MADE SECURE BEFORE BEING USED AS A PLATFORM. THE ACCESS IS NOT LOAD BEARING AND SHOULD NOT BE USED FOR ANYTHING OTHER THAN ACCESS FOR CONCRETE POURING [REFER TO DRAWINGS NO FFS-APHR# FOR MORE DETAILS].

9. IF IN DOUBT OF ANYTHING PLEASE CALL OUR OFFICE, WE ARE HERE TO HELP.

REVISION	DATE	DESCRIPTION	SIGNED
0	4/06/15	ORIGINAL VERSION	K.P.
B	4/06/17	ANNUAL REVISION	K.P.



www.fastformsystems.com

info@fastformsystems.com

Tel South: 00 44 (0) 203 507 1832 / 507 1833 / 507 1834

Tel North: 00 44 (0) 1472 488230 / 488660 / 485640



Head Office:
Unit 1
Omega Business Park
Estate Road 6
Grimsby
N.E.Lincs
DN31 2TG

LEGAL NOTICE:

Fast Form™ is the Trade Mark of Fast-Form Systems Ltd and all designs are copyright and intellectual property of Fast-Form Systems Ltd and may not be reproduced or used without permission. Fast Form™ is covered by the following Patents: granted GB2508263 / GB2533172 Patents Pending GB 1616005.3 / GB 1506126.0 / US-2016-0194887 / PCT W02016 / 110663 / EP 14780541.0 / PCT GB2014 / 052586. Copyright or Trade Mark infringements will be prosecuted, if you see any similar bracket in operation without our name on it please send us an email to info@fastformsystems.com we offer a reward for all successful prosecutions.

Drawn By: Karol Podsiadlo	Date: 04/06/15	Rev: B
Designed by: Karol Podsiadlo	Drawing no: FFS-WSEG1	
Project: Fast Form Wall System		
Drawing title: Wall System Erection Step by Step Guide (2-sided)		