

REVISION	DATE	DESCRIPTION	SIGNED
0	4/06/15	ORIGINAL VERSION	K.P.
A	4/06/16	ANNUAL REVISION	K.P.

BRACKET SYSTEM ERECTION STEP BY STEP GUIDE (BASE WITH FIXING TO DECKING)

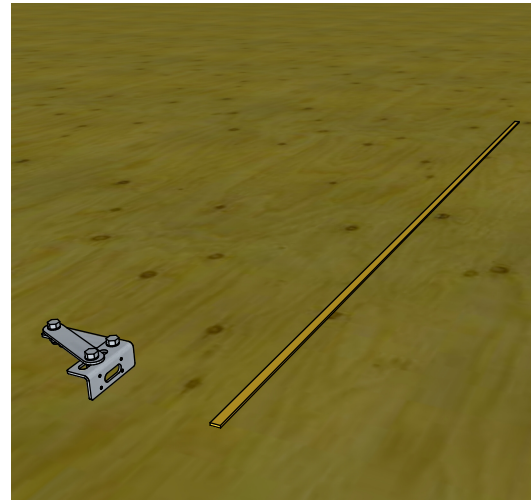

STEP ONE:
MARK THE LINE OF THE SHUTTER DEDUCTING THE PLY THICKNESS. CENTRES OF THE BRACKETS ARE DEPENDENT ON THE REQUIRED FINISH OR SIZE OF YOUR POUR (REFER TO NOTE NO 3).

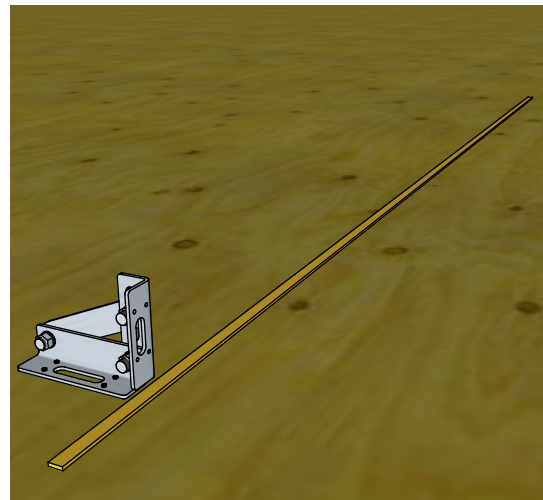

STEP TWO:
FIX DOWN THE FIRST BRACKET USING 25MM SCREWS. **REMEMBER TO USE ALL AVAILABLE HOLES** IN THE HORIZONTAL MEMBER AS THIS WILL PREVENT THE BRACKET FROM BEING PUSHED AWAY FROM THE SHUTTER.

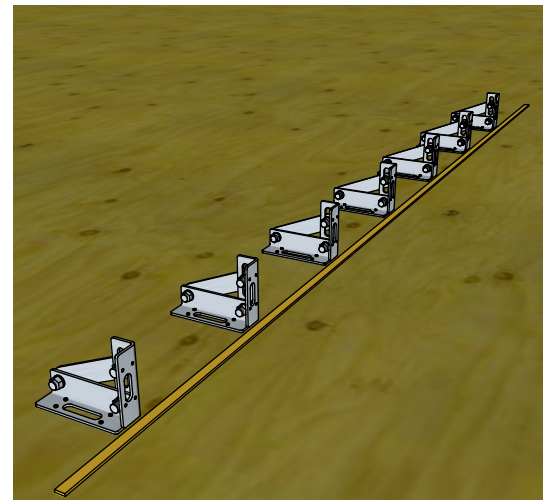

STEP THREE:
FIX DOWN ALL REQUIRED BRACKETS. FOR ALIGNING THE BRACKET SYSTEM PLUMB THE FIRST AND LAST BRACKET ONLY, LOOSEN THE BOLTS ON THE DIAGONAL MEMBERS OF THE REMAINING BRACKETS. ATTACH A STRING LINE TO THE TOP OF THE FIRST AND LAST BRACKET MAKING SURE IT IS TIGHT. ADJUST EACH BRACKET INDIVIDUALLY, BRINGING THE FACE OF THE UPRIGHT MEMBER TO THE STRING LINE BEFORE FULLY RE-TIGHTENING THE BOLTS WITH AN IMPACT WRENCH !

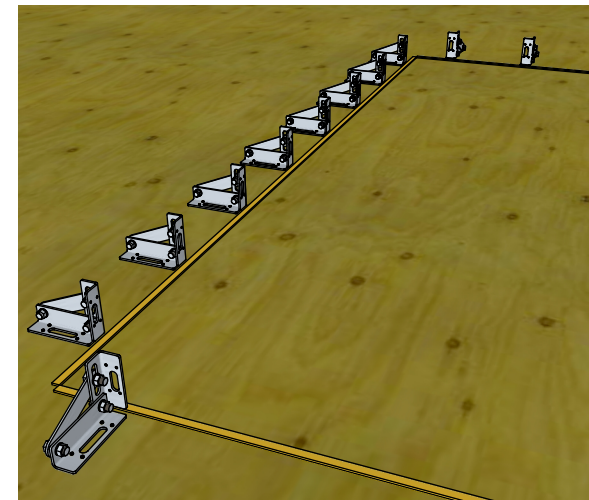

STEP FOUR:
CONTINUE THE PROCESS AROUND THE POUR OF THE SLAB. REMEMBER TO LEAVE SPACE FOR CORNER ACCESSORIES. IF IT'S A BEAM, SIMPLY REPEAT PREVIOUS STEPS FOR THE OTHER SIDE OF THE BEAM.

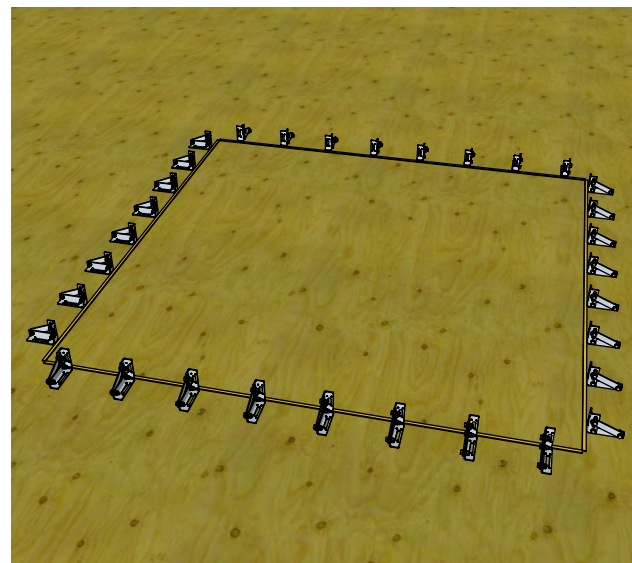

STEP FIVE:
AFTER ALL THE BRACKETS ARE SECURED, YOU ARE READY TO FIX THE PLYWOOD TO THE BRACKETS WITH SCREWS.

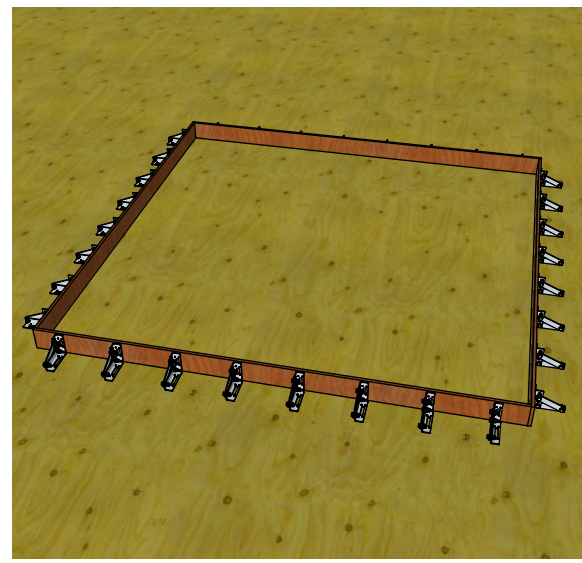

STEP SIX:
FIT ALL PLY (FROM BEHIND) USING 25MM SCREWS. PLY TO BE A MIN. 18MM STRUCTURAL GRADE.

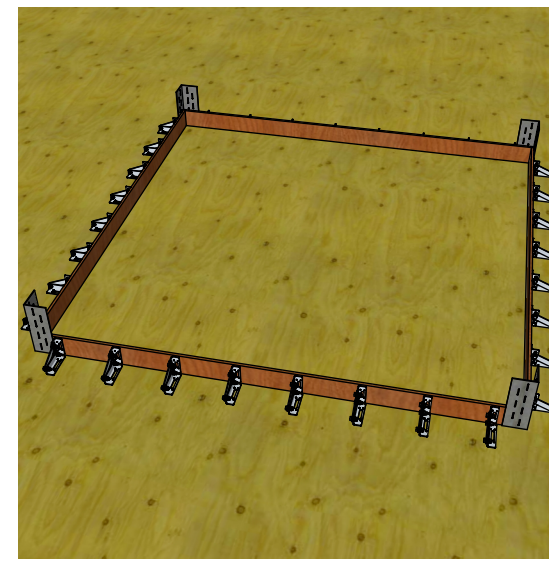

STEP SEVEN:
POSITION THE EXTERNAL CORNER ACCESSORIES IN PLACE AND FIX TO PLY USING ALL AVAILABLE HOLES.

NOTES:

THESE ARE STANDARD FITTING INSTRUCTIONS FOR THE FAST FORM BRACKET SYSTEM, YOU SHOULD BE ABLE TO COMPLETE ANY SIZE OR TYPE OF POUR FOLLOWING THESE:

1. START BY MARKING OUT THE LINE OF THE SHUTTER (REMEMBER TO DEDUCT THE PLY THICKNESS). FIX DOWN THE BRACKETS USING 25MM WOOD SCREWS. ALL SCREWS TO BE FIXED WITH AN ELECTRIC DRILL.
2. REMEMBER THAT THE BRACKETS HAVE TO BE FIXED WITH WOOD SCREWS USING ALL AVAILABLE HOLES!
3. CENTRES OF THE BRACKETS TO BE NO MORE THAN 400MM FOR FAIR FACE FINISH. FOR CENTRES REFER TO THE DETAILED DRAWING OR SPECIFICATIONS FOR YOUR ORDER.
4. WISAFORM MDO PLY IF SUPPLIED BY FAST FORM SYSTEMS, THE LIGHT BROWN FACE IS THE FACE TO USE FOR THE CONCRETE SIDE, NOT THE DARK BROWN FACE. MOULD OIL / RELEASE AGENT SHOULD BE APPLIED TO THE FACE SIDE OF ALL PLY FOR EASY RELEASE AFTER CONCRETING.
5. IF IN DOUBT OF ANYTHING PLEASE CALL OUR OFFICE, WE ARE HERE TO HELP.



www.fastformsystems.com

info@fastformsystems.com

Tel South: 00 44 (0) 0203 507 1832 / 507 1833 / 507 1834

Tel North: 00 44 (0) 1472 488230 / 488660 / 485640



Head Office:
Unit 1
Omega Business Park
Estate Road 6
Grimsby
N.E.Lincs
DN31 2TG

LEGAL NOTICE:

Fast Form™ is the Trade Mark of Fast-Form Systems Ltd and all designs are copyright and intellectual property of Fast-Form Systems Ltd and may not be reproduced or used without permission. Fast Form™ is covered by the following Patents: granted GB2508263 / GB2533172 Patents Pending GB 1616005.3 / GB 1506126.0 / US-2016-0194887 / PCT W02016 / 110663 / EP 14780541.0 / PCT GB2014 / 052586. Copyright or Trade Mark infringements will be prosecuted, If you see any similar bracket in operation without our name on it please send us an email to info@fastformsystems.com we offer a reward for all successful prosecutions.

Drawn By: Karol Podsiadlo

Date: 04/06/15

Rev: A

Designed by: Karol Podsiadlo

Drawing no: FFS-BSEG2

Project: Fast Form Bracket System

Drawing title: Bracket System Erection Step by Step Guide